

- ^{ぶんどき}分度器の中心を点アに合わせて次の角度をかきましょう。

1 105°

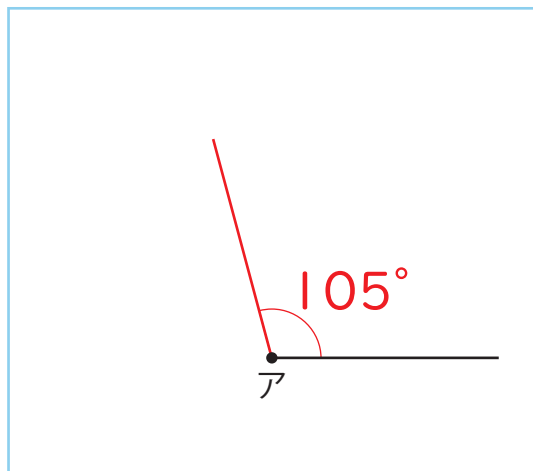

2 160°

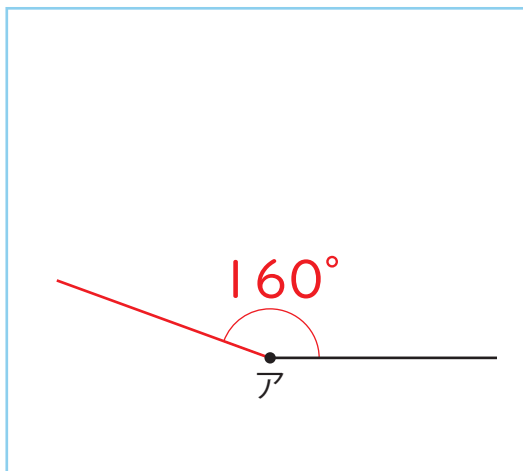

3 125°

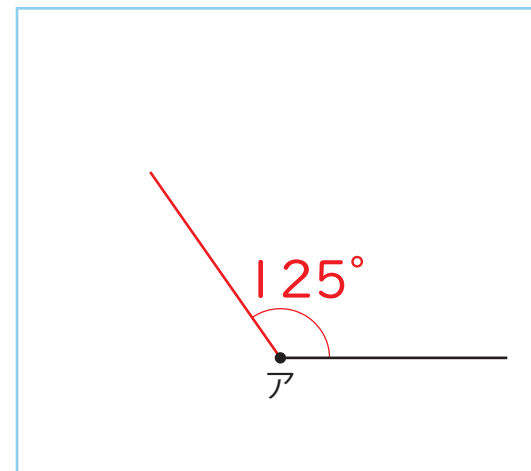

4 115°

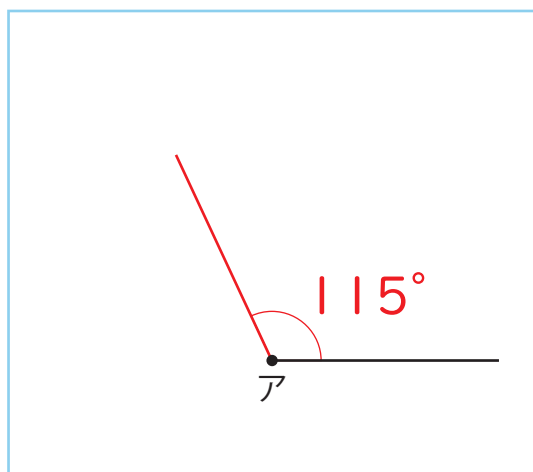

5 110°

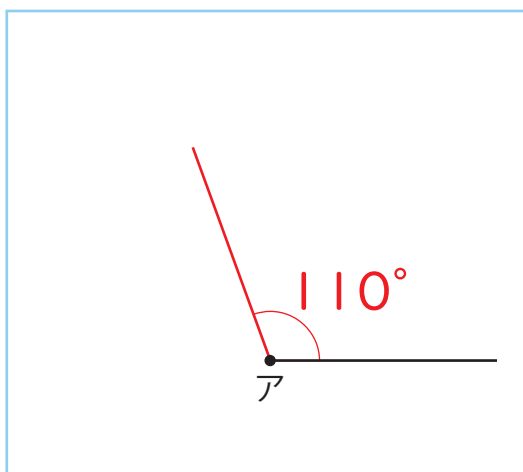

6 165°

